



## **CLASSIC & PRESTIGE**

Installation manual

REV 1 - 1.2013

# WELCOME

---

Dear Installer

This manual contains advice for a rapid and precise installation of the PRESTIGE awning systems. Although we are sure that you know how to use our products, we still recommend that you read our instructions carefully. We always welcome any suggestions or comments on possible improvements to the installation techniques or the layout of the manual. We would also remind you that during installation you should always use materials that best comply with the environmental conditions.

It is good practice to issue a final declaration of correct installation according to the specifications given in this manual, in addition to the mandatory declarations of conformity required by law, where requested. All technical interventions necessary for the installation must be carried out by authorized and specialised technicians. All unauthorized interventions (tampering, technical modification etc.) during the warranty period will invalidate said warranty.

ShadeTree Cool Living reserves the right to make technical modifications to the components or products, except for the main features, at any time and without prior notice.

## INDEX

Symbols	2
General Precautions	2
General safety precautions	2
Precautions and warnings	2
Preliminary checks	3
Disposal of packaging materials	3
Choice of glass	3
Material check, unpacking and preparation	4
Features	5
1 Fixing Support Bracket	6
2 Installing the Awning	10
3 Attaching the Hood	12
4 Adjusting the Pitch	14
5 Awnings Over 23'	16
6 Canvas Replacement	20

# SYMBOLS

## SYMBOLS

The symbols indicated are used to draw the attention of the installer to arguments of particular importance for the safety of persons, the product or to indicate particular operating conditions.



Attention: general operating note

Attention: greater attention to what you are reading

Attention: general hazard; possible risk of damage to persons, property, components

Attention: risk of electrical hazard

Attention: risk of crushing hands

Contact: ShadeTree Cool Living or the authorized retailer

## GENERAL PRECAUTIONS

Before undertaking any assembly, maintenance or cleaning operations, make sure that you have fully understood the indications in this manual.

Failure to comply with the regulations contained herein relieves ShadeTree Cool Living of all responsibility for damage caused to persons, animals, property and/or components.

The installation personnel must scrupulously comply with the local accident prevention regulations in force.



All electrical connections for movement, installation of automation accessories etc. must only be made by qualified personnel.

If the structure is motorized and installed at a height of less than 8' from the ground, the control button must be of the 'dead-man' type and the opening and closing operations must be clearly visible.



In case of any problems, contact ShadeTree Cool Living

## GENERAL SAFETY WARNINGS

PRESTIGE are designed for a specific use (as outlined in this manual); any use other than that envisioned shall relieve ShadeTree Cool Living of any responsibility.

When using the awning it is good practice to remember that all moving parts can be a source of danger.



It is compulsory to cut off the power supply (if present) when carrying out an installation, maintenance, repair or adjustment.



It is recommended that a caution sign be placed on the power supply master switch with the following indications:

"Attention! Do not touch. Service personnel at work".

## PRECAUTIONS AND WARNINGS

The maintenance and installation personnel (installers, electricians etc.) must have sufficient expertise as well as psychophysical and attitudinal requirements for undertaking the tasks at hand. Always check the correct mounting and working efficiency of the electrical and manual drives during the assembly.



In case of anomalies, immediately stop the work and contact the service department of ShadeTree Cool Living



The use of non-original spare parts, or unauthorized tampering or modifications shall relieve ShadeTree Cool Living of any responsibility for damage caused to persons, animals or property.

It is strictly forbidden to tamper with the fixings, the supports, the guides, the fixtures, the drive and idler units and any other PRESTIGE components.

# SYMBOLS

---



## **WARNING**

All values indicated are expressed in inches (unless otherwise specified).

## **PRELIMINARY CHECKS**

On receipt of the packed goods and before starting their assembly, check the integrity of the material and the presence of all the components necessary for the installation. Carefully follow the information contained in the "Material check, unpacking and preparation" section.



In case of anomalies, immediately contact the authorized retailer or ShadeTree Cool Living

## **DISPOSAL OF PACKAGING MATERIALS**

Divide the various packaging according to the material used (cardboard, nylon, polystyrene etc.) and dispose of them separately in compliance with governmental regulations.

## FEATURES

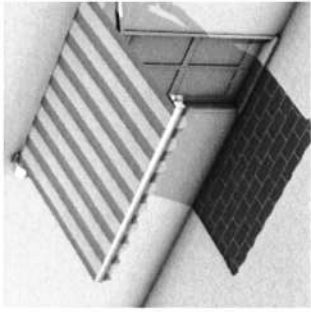

The PRESTIGE system enables easy fitting of the awning mechanism, thus the entire awning system can be installed quickly and easily on a 40mm x 40mm square bar and it benefits from the simple arm adjustment system. The design of the PRESTIGE follows the same refined lines and special emphasis on concealing visible screws. Like all ShadeTree Cool Living models, the PRESTIGE design can match well with any outdoor decor.

Since the PRESTIGE system is designed to cover such large areas, all the pieces composing the set have been made as small as possible to enhance the appearance of the installation. All of these components are made of powder coated aluminum and/or steel for a very sleek contemporary look giving it an unobtrusive design concept. Frame colors include: White (RAL9016), Tan (RAL1015), and Mocha (RAL1019).

The PRESTIGE awning can be motorized or with a manual gear spring assisted option for easily retracting the awning. Wind and other types of sensors are available to help extend the life of your awning. When retracted with wall mounted brackets, the system measures 11" P x 11" H. The two piece flat hood option adds 2" to the overall projection and height.

ShadeTree Cool Living offers a limited lifetime warranty on the frame and arms, with a 5 year manufacturer's warranty on the motor. Parà TEMPOTEST® fabrics are guaranteed against the loss of color for 10 years.

## WALL BRACKET

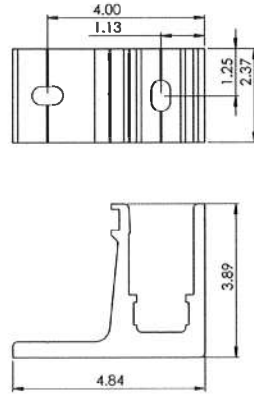
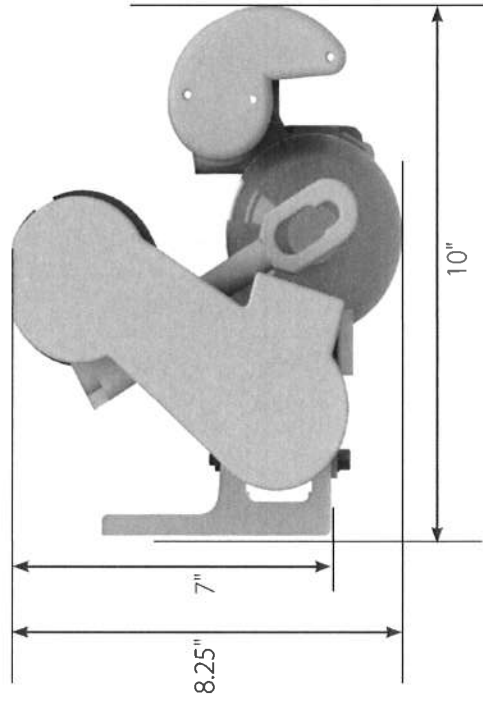

## CEILING BRACKET

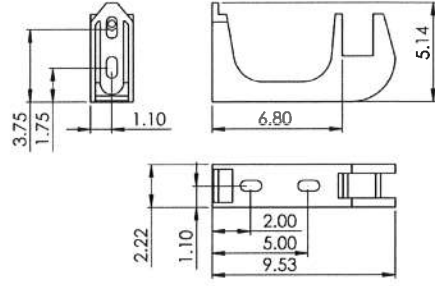
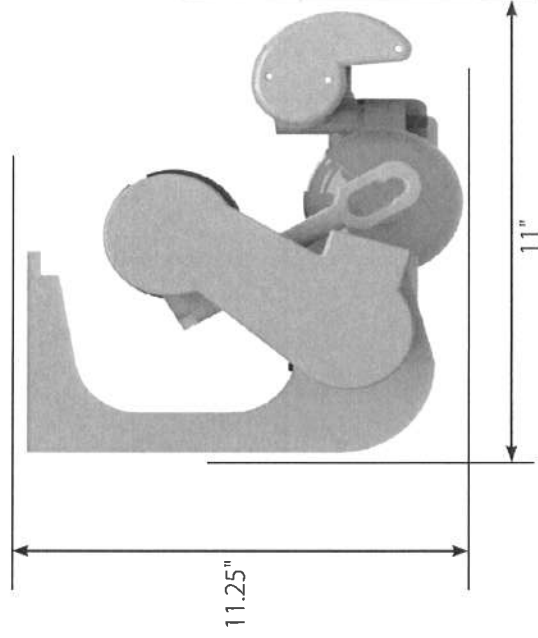

# FIXING SUPPORT BRACKETS 1

Wall



Wall

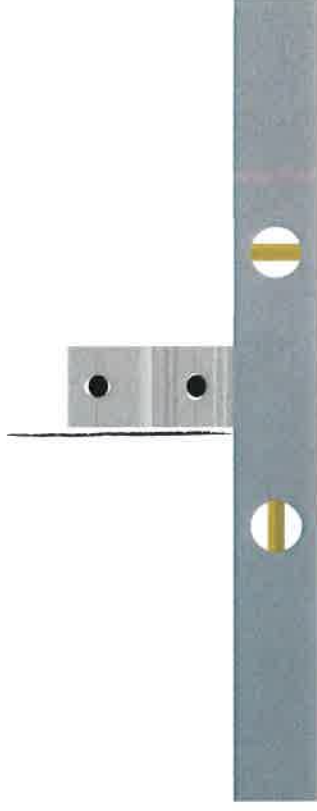

FLOOR

Mark out a horizontal line along the wall where the base of the awning will be placed. Mark two vertical lines for the outside wall brackets spaced the width of the awning less 12".

Mark the recommended placement of the intermediate support brackets using the diagram on page 9 for approximate locations.

While using a level, place an outside bracket on the wall and mark the bolt slots. Using appropriate hardware for the job, drill the marked holes and mount the bracket. Use a level to ensure it is parallel to the ground when tightened.

# 1 FIXING SUPPORT BRACKETS

## Wall



Using either a level or a straight bar with a level, place the next bracket on the wall and mark and mount in a similar fashion as the first end bracket. Repeat this process until all brackets have been mounted.

## Ceiling

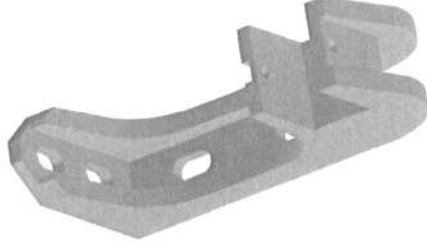

Mark out a line where the back edge of the ceiling bracket will be placed. Mark 2 perpendicular lines for the outside ceiling brackets spaced a width of the awning less 12".



# FIXING SUPPORT BRACKETS

1

## Ceiling



While using a roofing square, place the outside bracket on the ceiling and mark the screw slots. Using appropriate hardware for the job, drill the marked holes and mount the bracket. Use a roofing square to ensure the bracket is perpendicular to the edge of the roof.

## Ceiling



Using either a level or a straight bar with a level, place the next bracket on the wall and mark and mount in a similar fashion as the first end bracket. Repeat this process until all brackets have been mounted.

# 1 FIXING SUPPORT BRACKETS

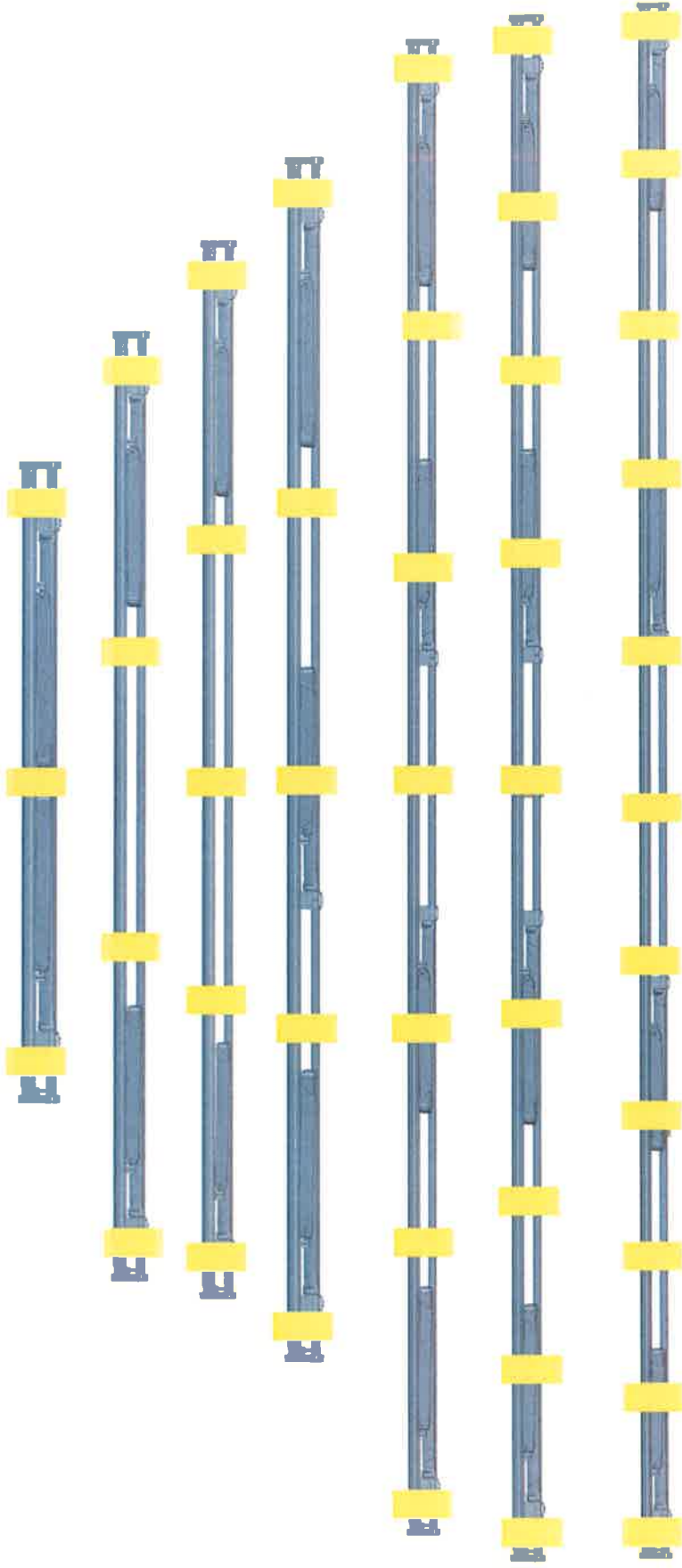

Based on the number of arms and brackets that are supplied with your awning, locate the approximate placement of the brackets for your job.  
Note: Awnings are not to scale.



Using an appropriate number of people, or a sheetrock lift, lift the awning's squarebar into the mount's opening. The squarebar should snap into place. Center the awning and secure it with the supplied bolts and nuts as shown above.



Place the supplied bolt covers on the awning's mounts as shown above.

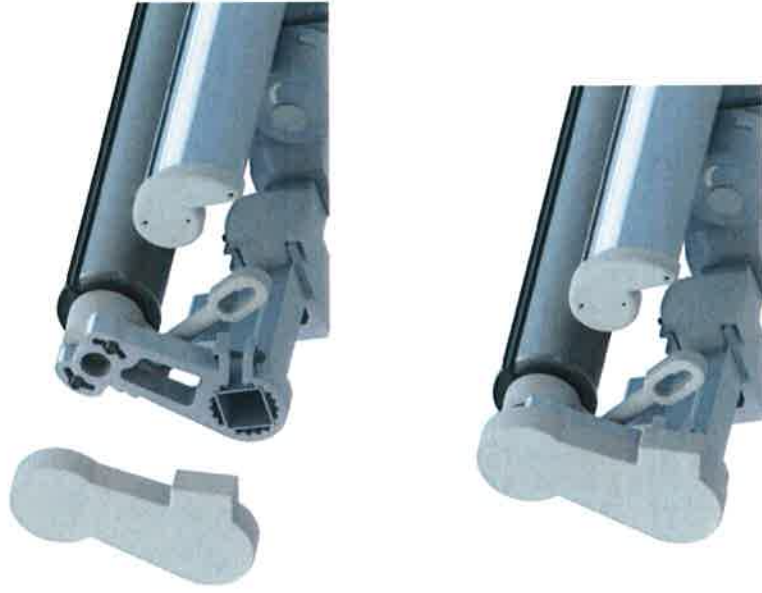

Place endcap on the PRESTIGE's end bracket as shown. The endcap will snap into the bracket.

# ATTACHING THE HOOD

2



Attach hood support bracket a few inches from each wall bracket. Use the supplied bolts and nuts to fasten down.



Slide the two pieces of the hood together and insert the bolts into the outer slots.

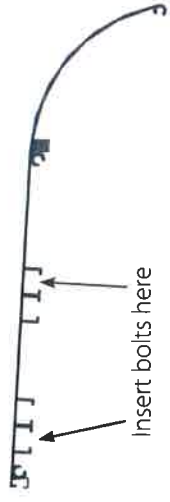



Place hood onto hood brackets and center the hood. Ensure bolts fall within the hood bracket slots. Tighten down with nuts.



Attach hood endcap with 3 screws as show on each side.

# ADJUSTING THE PITCH

## 4

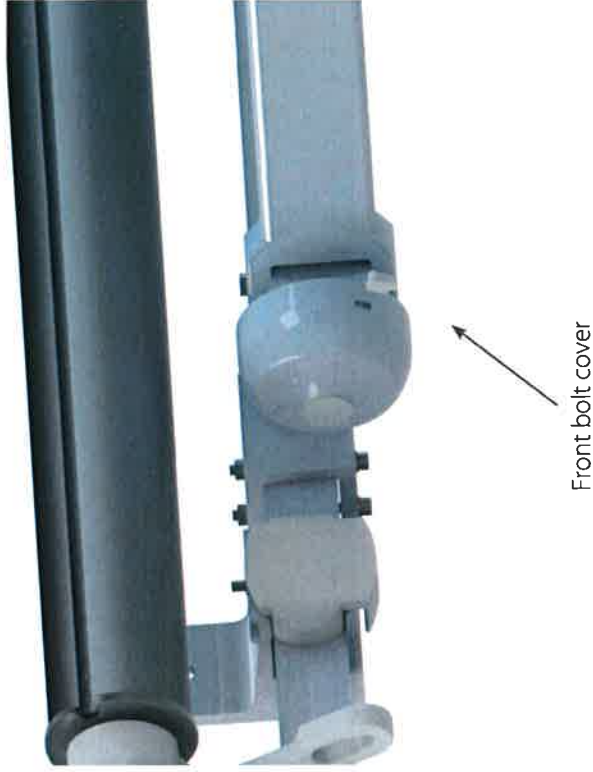

Fully extend the awning and then loosen the side bolt and remove the front bolt cover on all arm brackets.



While having someone slightly lift the frontbar of the awning, adjust the pitch by turning the front bolt on the arm bracket.



Adjust all arm brackets together in small increments of no more than about 1/2 turn of the bolt.



Clockwise lowers  
Counter-clockwise raises



Once the awning is at the desired pitch place a level on the frontbar and slightly adjust the pitch to level the frontbar.



Replace the front adjustment bolt cover and tighten the side bolt on all arm brackets.





PRESTIGE's over 23' will be shipped in two pieces. You will need to splice the two halves on site before you install the awning in the mounting brackets. Once you have installed the mounting brackets as per the instructions in Section 1, you will need to complete the splice on site as outlined in this section, hang the awning without fabric (Section 2), and then install the fabric (Section 6).

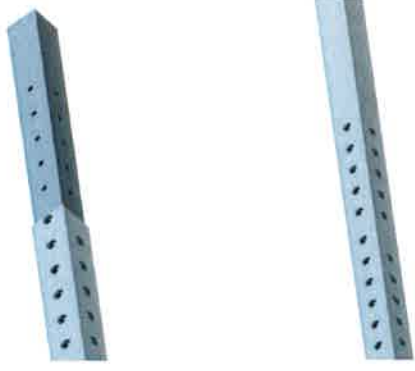

Insert the square bar splice into the free end of the other square bar. Pop all ten (10) rivets (rivets have a 3/32" shaft).



Following the directions in Section 2, place the awning in the mounting brackets.



To splice together PRESTIGE's hood, place the bar into the bolt slots as shown & tighten the set screws. Follow the directions in Section 2 to install the hood.



The curved profile for the hood does not have a physical splice connector.



The slice for the flat and curved hood profiles should not line up.



In the same manner as the square bar, splice the roller tube and the front bar of the awning.



Remove the idle end cap from the awning, and follow the directions in Section 6.



## REPLACING THE FABRIC

6



Open the awning about 1' and tie down all arms. Unroll the fabric to relieve tension on it and ensure the arms are secure. **WARNING!**

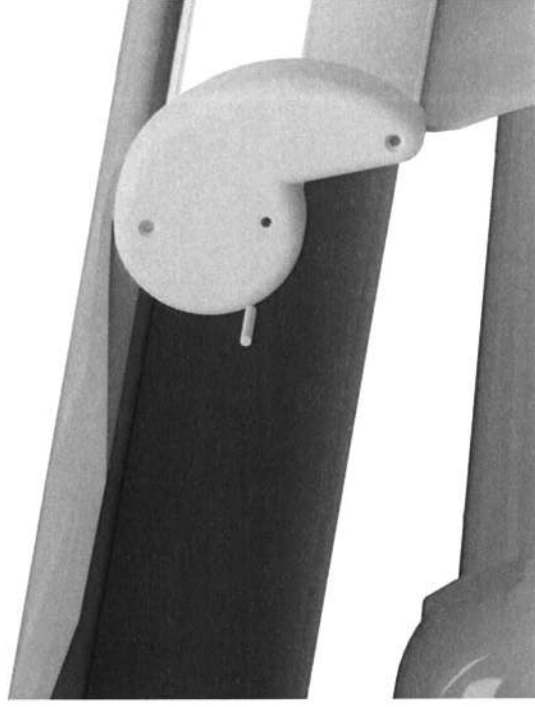

Remove the screw securing the front bar end cap.



Remove the screws tensioning the fabric & valance in the front bar.



Slide the valance out if present.

## REPLACING THE FABRIC

6

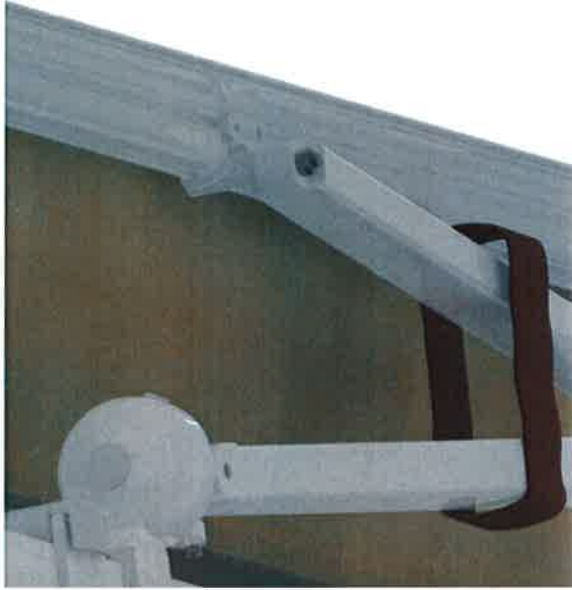

Remove bolt connecting the front bar to each arm.



Remove the end cap.

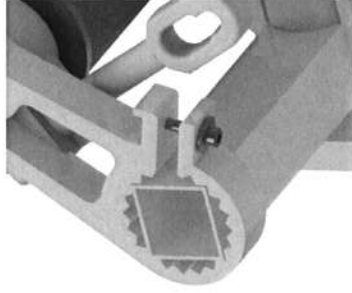

Remove the idle end bracket by loosening the screw where shown if you need to remove the roll tube to slide the fabric out. The roll tube will fall out.



With the roll tube on the ground or in the awning, slide the fabric out from the roll tube and the front bar.

**To replace with a new fabric follow the prior steps in reverse.**